

## For Precision Control HarmonicDrive® Speed Reducer

# CSF-3 Series Manual

---

- Thank you very much for your purchasing our HarmonicDrive CSF-3 series.
- Be sure to use sufficient safety measures when installing and operating the equipment so as to prevent an accident resulting in a serious physical injury damaged by a malfunction or improper operation.
- Product specifications are subject to change without notice for improvement purposes.
- Keep this manual in a convenient location and refer to it whenever necessary in operating or maintaining the units.
- The end user of the driver should have a copy of this manual.

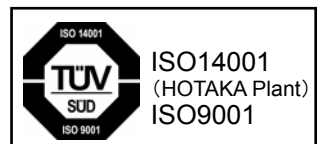



# SAFETY GUIDE

For HarmonicDrive® component and unit



Read this manual thoroughly before designing the application, installation, maintenance or inspection of the actuator.



**WARNING** Indicates a potentially hazardous situation, which, if not avoided, could result in death or serious personal injury.



**CAUTION** Indicates a potentially hazardous situation, which, if not avoided, may result in minor or moderate personal injury and/or damage to the equipment.





## LIMITATION OF APPLICATIONS:

The equipment listed in this document may not be used for the applications listed below:





- \* Space equipment
- \* Aircraft, aeronautic equipment
- \* Nuclear equipment
- \* Household apparatus
- \* Vacuum equipment
- \* Automobile, automotive parts
- \* Amusement equipment
- \* Machine or devices acting directly on the human body
- \* Instruments or devices to transport or carry people
- \* Apparatus or devices used in special environments
- \* Instruments or devices to prevent explosion

Safety measures are essential to prevent accidents resulting in death, injury or damage of the equipment due to malfunction or faulty operation.





### Design Precaution: Be certain to read the catalog when designing the equipment.

 <p><b>CAUTION</b></p> <p>Use only in a specified environment.</p> <ul style="list-style-type: none"> <li>● Please ensure the following environmental conditions are complied with:             <ul style="list-style-type: none"> <li>- Ambient temperature 0 to 40°C .</li> <li>- No contamination by water, oil</li> <li>- No corrosive or explosive gas</li> <li>- No dust such as metal powder</li> </ul> </li> </ul>	 <p><b>CAUTION</b></p> <p>Install the equipment in a specified manner.</p> <ul style="list-style-type: none"> <li>● Carry out assembly precisely in the specified order according to the catalog.</li> <li>● Observe our recommended tightening methods (such as bolts used).</li> <li>● Operating the equipment without precise assembly can cause troubles such as generation of vibration, reduction of life, deterioration of precision and breakdown. Use the specified lubricant.</li> </ul>
 <p><b>CAUTION</b></p> <p>Install the equipment in a specified precision.</p> <ul style="list-style-type: none"> <li>● Design and assemble parts to keep the recommended installation precision on the catalog.</li> <li>● Failure to keep the precision can cause troubles such as generation of vibration, reduction of life, deterioration of precision and breakdown.</li> </ul>	 <p><b>CAUTION</b></p> <p>Use the specified lubricant.</p> <ul style="list-style-type: none"> <li>● Using other lubricant than our recommended products can reduce the life. Replace the lubricant in a specified condition.</li> <li>● Grease is sealed in a unit product. Do not mix other kinds of grease.</li> </ul>

### Operational Precaution: Be certain to read the catalog before operating the equipment.

 <p><b>CAUTION</b></p> <p>Be careful in handling products and parts.</p> <ul style="list-style-type: none"> <li>● Do not give strong shock to parts and units with a hammer. Do not scratch or bruise them. Possible damage is assumed.</li> <li>● If you use the equipment in a damaged condition, the specified performance may not be retained. It can also cause troubles such as breakdown.</li> </ul>	 <p><b>CAUTION</b></p> <p>Apply torque within the allowable range.</p> <ul style="list-style-type: none"> <li>● Do not apply torque exceeding the instantaneous allowable max. torque. Applying excess torque can cause troubles such as loose tightening bolts, generation of backlash and breakdown.</li> <li>● Striking an arm directly attached to the output shaft can damage the arm and make the output shaft uncontrollable.</li> </ul>
 <p><b>CAUTION</b></p> <p>Do not change a set of parts.</p> <ul style="list-style-type: none"> <li>● The product is manufactured with sets of parts. the specified performance may not be retained if you have used mixed sets of parts.</li> </ul>	 <p><b>CAUTION</b></p> <p>Do not break down unit products.</p> <ul style="list-style-type: none"> <li>● Do not break down and reassemble unit products. Original performance may not be reproduced.</li> </ul>

### Handling lubricant

 <p><b>WARNING</b></p> <p>Precautions on handling lubricant</p> <ul style="list-style-type: none"> <li>● Lubricant got in the eye can cause an inflammation. Wear protective glasses to prevent it from getting in your eye when you handle it.</li> <li>● Lubricant coming in contact with the skin can cause an inflammation. Wear protective gloves to prevent it from contacting your skin when you handle it.</li> <li>● Do not eat it (to avoid diarrhea and vomiting).</li> <li>● When you open the container, you might have your hand cut by it. Wear protective gloves.</li> <li>● Keep lubricant off children.</li> </ul>	 <p><b>CAUTION</b></p> <p>Treatment of waste oil and containers</p> <ul style="list-style-type: none"> <li>● Treatment methods are obliged by law. Treat wastes appropriately according to the law. If you are unsure how to treat them, you should consult with the dealer before treating them.</li> <li>● Do not apply pressure on an empty container. The container may blow up.</li> <li>● Do not weld, heat, drill or cut the container. The remainder may ignite with an explosion.</li> </ul>
 <p><b>WARNING</b></p> <p>First-aid</p> <ul style="list-style-type: none"> <li>● If lubricant gets in your eye, you should wash your eye with clean water for 15 minutes and submit to medical treatment.</li> <li>● If lubricant comes in contact with your skin, you should thoroughly wash it with water and soap.</li> <li>● If you swallowed it, you should immediately submit to medical treatment without throwing it up by constraint.</li> </ul>	 <p><b>CAUTION</b></p> <p>Storage</p> <ul style="list-style-type: none"> <li>● Tightly plug the container after use to prevent intrusion of dusts and water. Avoid direct sunlight to store lubricant in a dark place.</li> </ul>

### Disposal

 <p><b>CAUTION</b></p> <p>Please discard as industrial waste.</p> <ul style="list-style-type: none"> <li>● Please discard as industrial waste when discarding.</li> </ul>	
--	--

# Contents

<b>Chapter 1 Outlines of CSF-3 series .....</b>	<b>1</b>
1-1 Model and sign.....	1
1-2 Model .....	1
1-3 External drawing .....	2
<b>Chapter 2 Installing of Motor.....</b>	<b>3</b>
2-1 Checking procedure.....	3
2-2 Main bearing specification .....	3
2-3 How to obtain the maximum load moment load.....	4
2-4 How to obtain the average load .....	4
2-5 How to obtain the radial load coefficient (X) and axial load coefficient (Y).....	5
2-6 How to obtain the life.....	5
2-7 How to obtain the life under oscillating movement .....	6
2-8 How to obtain the static safety coefficient.....	6
<b>Chapter 3 Efficiency characteristics .....</b>	<b>7</b>
3-1 Double-axial unit type (1U) .....	7
3-2 Gear head type (1U-CC).....	8
<b>Chapter 4 No-load running torque.....</b>	<b>10</b>
<b>Chapter 5 Starting torque and Overdrive starting torque .....</b>	<b>11</b>
<b>Chapter 6 Ratcheting torque and Buckling torque .....</b>	<b>12</b>
<b>Chapter 7 Angle transmission accuracy.....</b>	<b>13</b>
<b>Chapter 8 Vibration .....</b>	<b>14</b>
<b>Chapter 9 Rigidity.....</b>	<b>15</b>
<b>Chapter 10 Design and Precautions on assembly.....</b>	<b>17</b>
10-1 Embedding accuracy of gear head type (1U-CC).....	17
10-2 Tolerable load of input shaft of double-shaft unit type (1U) .....	18
10-3 Mounting in system .....	19
10-4 Mechanical accuracy .....	20
10-5 Lubricant .....	20

# Memo

This supplementary technical data incorporates technical data that is not included in our CSF-3 Series Catalog.

Please use this data hand in hand with the CSF-3 Series Catalog when you study the use of Harmonic Drive products in the design of your products.

## Chapter 1 Outlines of CSF-3 series

### 1-1 Model and sign

Model and sign of CSF-3 series are described as follows:

**CSF-3 B-50-1U-CC-□□**

①      ② ③ ④                      ⑤                      ⑥

①	Model name	HarmonicDrive CSF series
②	Model No.	3
③	Desing Version	B (New Version)
④	Reduction ratio	30:1/30 50:1/50 100:1/100
⑤	Model	1U:Double-shaft unit type 1U-CC:Gear head type
⑥	Specification	None=standard product SP=special specifications such as shapes and performance

### 1-2 Model

Model	Reduction ratio	Rated torque at input 2000r/min		Peak torque at start/stop		Allowable max. value of ave. load torque		Instantaneous Allowable max. torque		Allowable max. input rotational speed	Allowable ave. input rotational speed	Inertia moment (1/4GD <sup>2</sup> )
		Nm	kgf m	Nm	kgf m	Nm	kgf m	Nm	kgf m	r/min	r/min	kgcm <sup>2</sup>
3	30	0.06	0.006	0.13	0.013	0.10	0.010	0.22	0.022	10000	6500	1U:5.3×10 <sup>-7</sup> 1U-CC:7.0×10 <sup>-7</sup>
	50	0.11	0.011	0.21	0.021	0.13	0.013	0.41	0.040			
	100	0.15	0.015	0.30	0.029	0.23	0.023	0.57	0.056			

Note) Upper part of inertia moment is the value of 1U type, whereas, lower part is the value 1U-CC type.

Note) See the catalog in description of terms on the rated table.

## 1-3 External drawing

### ■ Double-shaft unit type [CSF-3-XX-1U]

Unit: mm

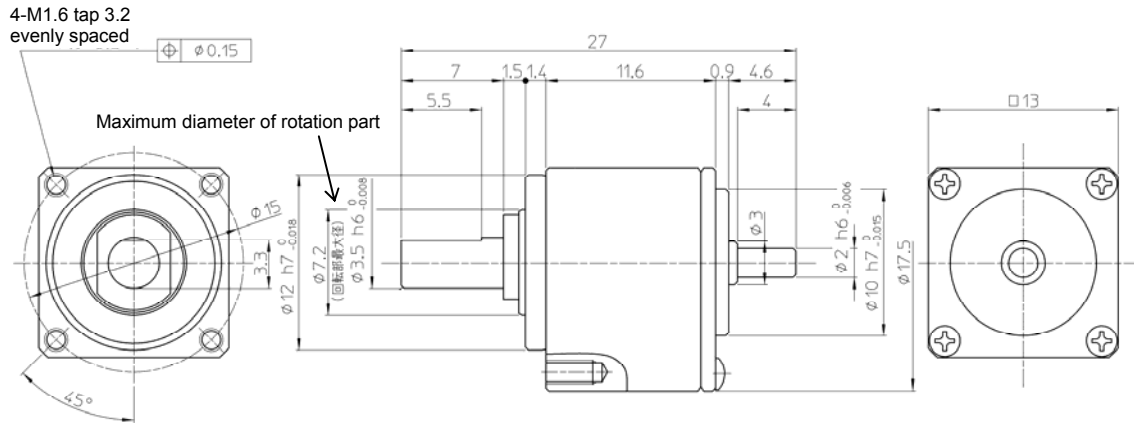

Mass: 13.7 g

### ■ Gear head type [CSF-3-XX-1U-CC]

Unit: mm

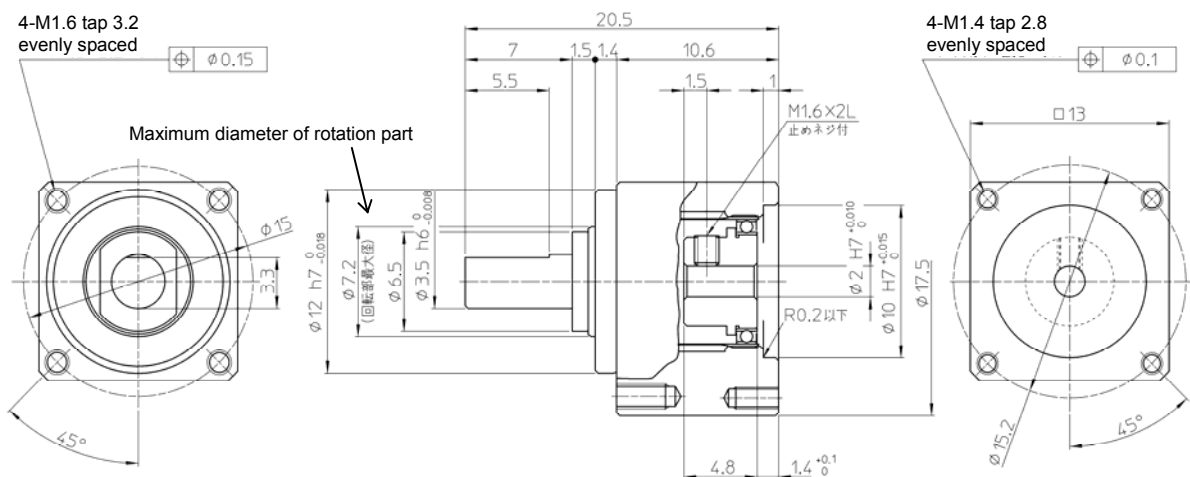

Mass: 11.4 g

Note) Please confirm the dimensions specification drawing issued by us for detail.

## Chapter 2 Installing of Motor

A precision cross roller bearing is built in the unit type and the gear head type to directly support the external load (output flange) (precision 4-point contact ball bearing for the CSF-mini series).

Check the maximum load moment load, life of the bearing and static safety coefficient to fully bring out the performance of the unit type.

### 2-1 Checking procedure

(1) Checking the maximum load moment load

Obtain the maximum load moment load (Mmax).



Maximum load moment load (Mmax) ≤ permissible moment (Mc)

(2) Checking the life

Obtain the average radial load (F<sub>rav</sub>) and the average axial load (F<sub>aav</sub>).



Obtain the radial load coefficient (x) and the axial load coefficient (y).



Calculate the life and check it.

(3) Checking the static safety coefficient

Obtain the static equivalent radial load coefficient (P<sub>0</sub>).



Check the static safety coefficient.

### 2-2 Main bearing specification

Table 1 Specification

Model No.	Ball pitch circle diameter (dp)	Offset (R)	Basic rated load		Moment load	Moment rigidity	Tolerable radial load	Tolerable thrust load
			Basic dynamic rated load	Basic static rated load				
	m	m	×10 <sup>2</sup> N	×10 <sup>2</sup> N	Nm	Nm/rad	N	N
3	0.0077	0.0041	6.65	4.24	0.27	0.9 × 10 <sup>2</sup>	36	130

## 2-3 How to obtain the maximum load moment load

How to obtain the maximum load moment load is shown below. Check  $M_{max} \leq M_c$ .

● Formula (1)

$$M_{max} = F_{rmax}(L_r + R) + F_{amax} \cdot L_a$$

Symbol of Formula (1)				
$F_{rmax}$	Maximum radial load	N(kgf)	See Figure 1.	
$F_{amax}$	Maximum axial load	N(kgf)	See Figure 1.	
$L_r, L_a$	-----	m	See Figure 1.	
$R$	Offset amount	m	See Figure 1 and Table 1.	

Figure 1 External load influence diagram

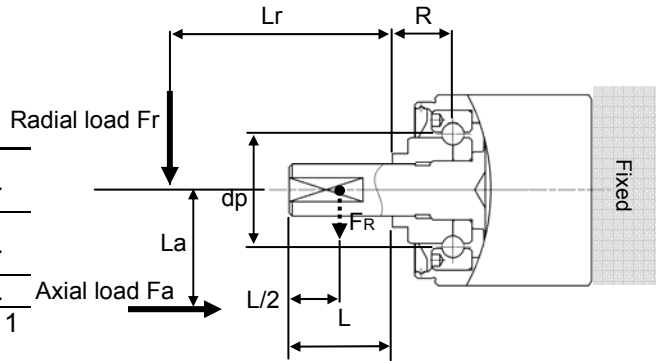

## 2-4 How to obtain the average load

(Average radial load, average axial load, average output rotational frequency)

If the radial load and the axial load fluctuate, they should be converted into the average load to check the life of the 4-point contact bearing.

● Formula (2) How to obtain the average radial load ( $F_{rav}$ )

$$F_{rav} = \sqrt[3]{\frac{n_1 t_1 (|F_{r1}|)^3 + n_2 t_2 (|F_{r2}|)^3 + \dots + n_n t_n (|F_{rn}|)^3}{n_1 t_1 + n_2 t_2 + \dots + n_n t_n}}$$

Note that the maximum radial load within the  $t_1$  section is  $F_{r1}$  and the maximum radial load within the  $t_2$  section is  $F_{r2}$ .

● Formula (3) How to obtain the average axial load ( $F_{aav}$ )

$$F_{aav} = \sqrt[3]{\frac{n_1 t_1 (|F_{a1}|)^3 + n_2 t_2 (|F_{a2}|)^3 + \dots + n_n t_n (|F_{an}|)^3}{n_1 t_1 + n_2 t_2 + \dots + n_n t_n}}$$

Note that the maximum axial load within the  $t_1$  section is  $F_{a1}$  and the maximum axial load within the  $t_2$  section is  $F_{a2}$ .

Graph: Load pattern and output rotational frequency

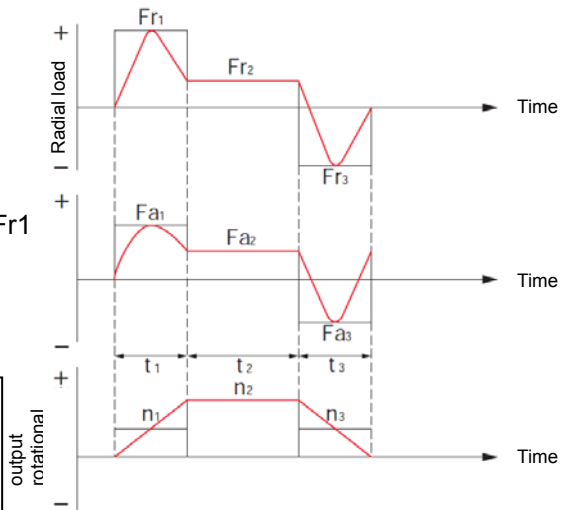

● Formula (4) How to obtain the average output rotational frequency ( $N_{av}$ )

$$N_{av} = \frac{n_1 t_1 + n_2 t_2 + \dots + n_n t_n}{t_1 + t_2 + \dots + t_n}$$



## 2-5 How to obtain the radial load coefficient (X) and axial load coefficient (Y)

●Formula (5) Table 2

	X	Y
$\frac{Faav}{Frav + 2(Frav(Lr + R) + Faav \cdot La) / dp} \leq 1.5$	1	0.45
$\frac{Faav}{Frav + 2(Frav(Lr + R) + Faav \cdot La) / dp} > 1.5$	0.67	0.67

Symbol of Formula (5)

$Frav$	Average radial load	N(kgf)	See "Average load."
$Faav$	Average axial load	N(kgf)	See "Average load."
$Lr, La$	—	m	See Figure 1.
$R$	Offset amount	m	See Figure 1 and Table 1.
$dp$	Pitch circle diameter of a roller	m	See Figure 1 and Table 1.

## 2-6 How to obtain the life

Obtain the life of the 4-point contact bearing by Formula (6).

You can obtain the dynamic equivalent radial load ( $Pc$ ) by Formula (7).

●Formula (6)

$$L_{B-10} = \frac{10^6}{60 \times Nav} \times \left( \frac{C}{fw \cdot Pc} \right)^3$$

Symbols of Formula (6)

$L_{B-10}$	Life	hour	
$Nav$	Average output rotational speed	r/min	See "How to obtain the average load."
$C$	Basic dynamic load rating	N(kgf)	See Table 1.
$Pc$	Dynamic equivalent radial load coefficient	N(kgf)	See Formula (7).
$fw$	Load coefficient	—	See Table 3.

Table 3 Load coefficient

Load status	$fw$
During smooth operation without shock or vibration	1~1.2
During normal operation	1.2~1.5
During operation with shock and vibration	1.5~3

●Formula (7)

$$Pc = X \cdot \left( \frac{2(Frav(Lr + R) + Faav \cdot La)}{dp} \right) + Y \cdot Faav$$

Symbols of Formula (7)

$Frav$	Average radial load	N(kgf)	See "How to obtain the average load."
$Faav$	Average axial load	N(kgf)	See "How to obtain the average load."
$dp$	Pitch circle diameter of a roller	m	See Figure 1 and Table 1.
$X$	Radial load coefficient		See Table 2.
$Y$	Axial load coefficient		See Table 2.
$Lr, La$	—	m	See Figure 1.
$R$	Offset amount	m	See Figure 1 and Table 1.

## 2-7 How to obtain the life under oscillating movement

Obtain the life of the bearing under oscillating movement by Formula (8).

● Formula (8)

$$L_{oc} = \frac{10^6}{60 \times n1} \times \frac{90}{\theta} \times \left( \frac{C}{f_w \cdot P_c} \right)^3$$

Symbols of Formula (8)

$L_{oc}$	Rated life under oscillating movement	hour	
$n1$	Number of reciprocating oscillations per minute	cpm	
$C$	Basic dynamic load rating	N(kgf)	See Table 1.
$P_c$	Dynamic equivalent radial load coefficient	N(kgf)	See Formula (7).
$f_w$	Load coefficient		See Table 3.
$\theta$	Oscillating angle/2	Angle	See Figure 2.

Figure 2 Oscillating movement

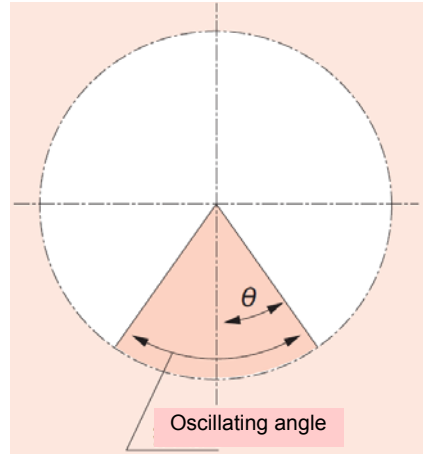

## 2-8 How to obtain the static safety coefficient

In general, the basic static load rating ( $C_o$ ) is considered to be the permissible limit of the static equivalent load. However, obtain the limit based on the operating and required conditions.

Obtain the static safety coefficient of the cross roller bearing by Formula (9). General values under the operating condition are shown in Table 4. You can obtain the static equivalent radial load ( $P_o$ ) by Formula (10).

● Formula (9)

$$f_s = \frac{C_o}{P_o}$$

Symbols of Formula (9)

$C_o$	Basic static load rating	N(kgf)	See Table 1.
$P_o$	Static equivalent radial load coefficient	N(kgf)	See Formula (10).

Table 4 Static safety coefficient

Operating condition of the roller bearing	$f_s$
When high rotation precision is required	$\geq 3$
When shock and vibration are expected	$\geq 2$
Under normal operating condition	$\geq 1.5$

● Formula (10)

$$P_o = F_{rmax} + \frac{2M_{max}}{d_p} + 0.44F_{amax}$$

Symbols of Formula (10)

$F_{rmax}$	Maximum radial load	N(kgf)	See "How to obtain the maximum load moment load"
$F_{amax}$	Maximum axial load	N(kgf)	
$M_{max}$	Maximum load moment load	Nm(kgfm)	
$d_p$	Pitch circle diameter of a roller	m	See Figure 1 and Table 1.

# Chapter 3 Efficiency characteristics

The efficiency varies depending on the following conditions.

- Reduction ratio ● Input rotational speed ● Load torque
- Temperature ● Lubrication condition (type and quantity of lubricant)

● Measuring condition

Load torque	The rated torque shown in the ratings (see the corresponding pages on each series)
Measuring condition	Grease lubrication Harmonic grease SK-2 Application quantity: Appropriate application quantity

## 3-1 Double-axial unit type (1U)

● Reduction ratio: 30

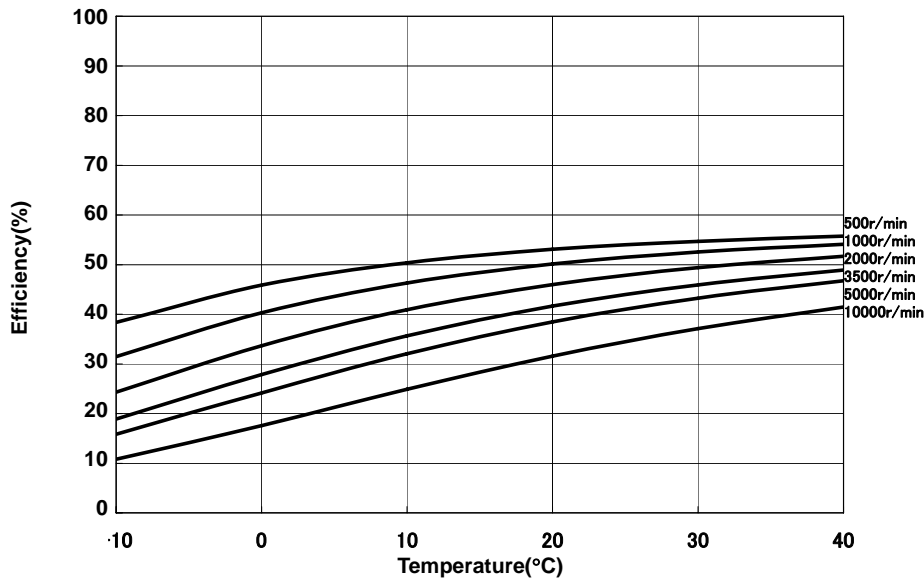

● Reduction ratio: 50

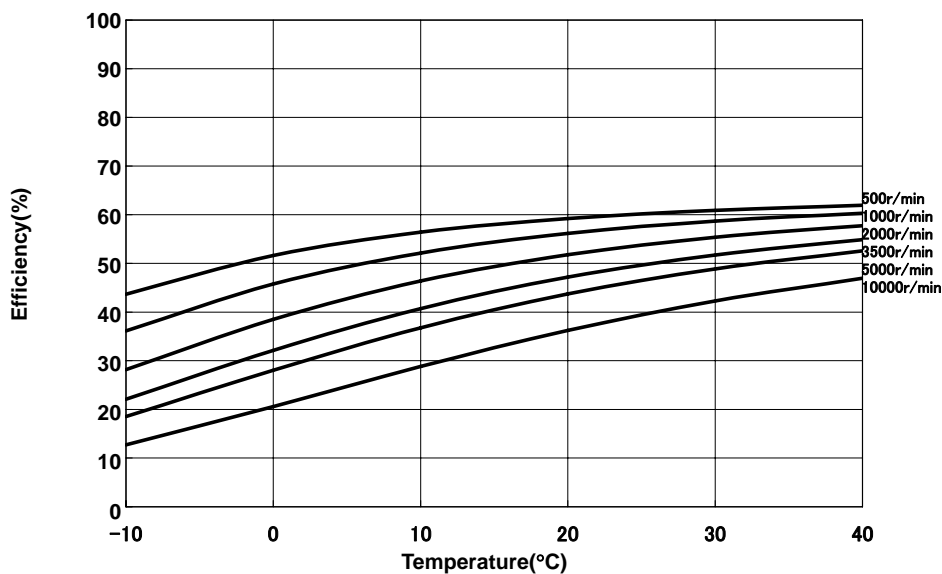

● Reduction ratio: 100

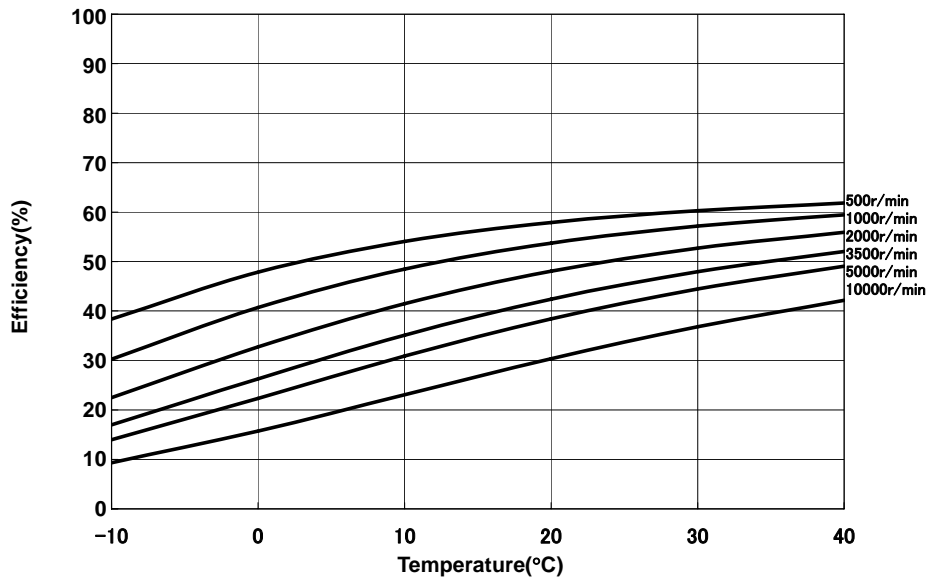

### 3-2 Gear head type (1U-CC)

● Reduction ratio: 30

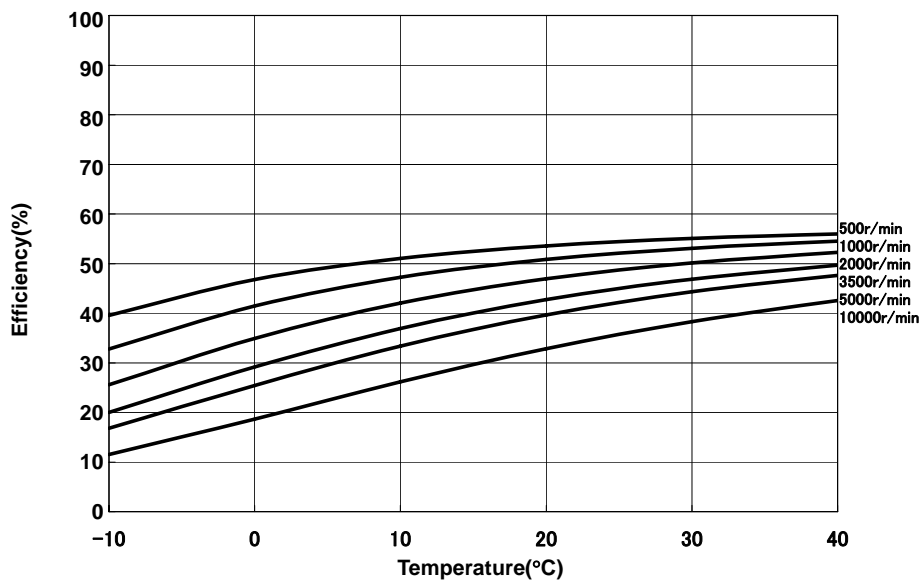

● Reduction ratio: 50

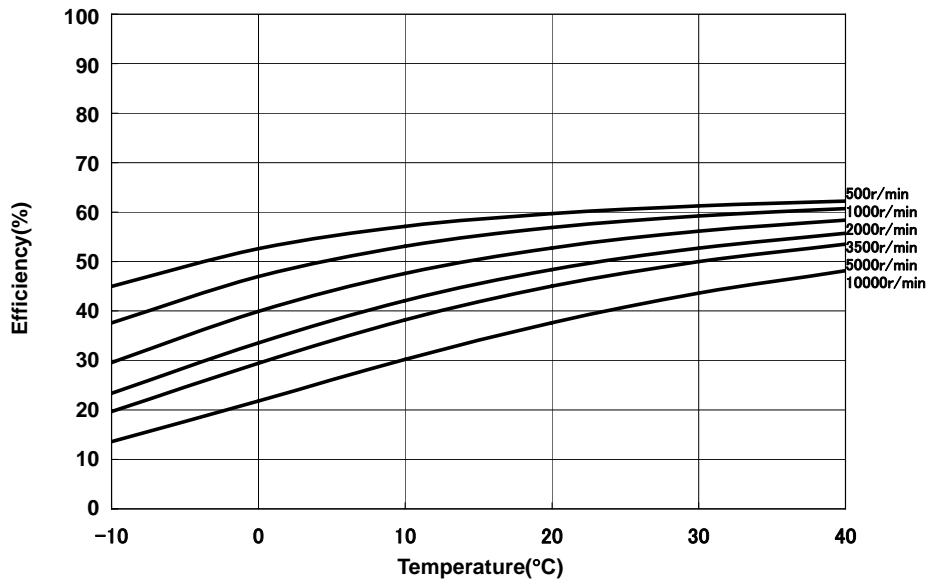

● Reduction ratio: 100

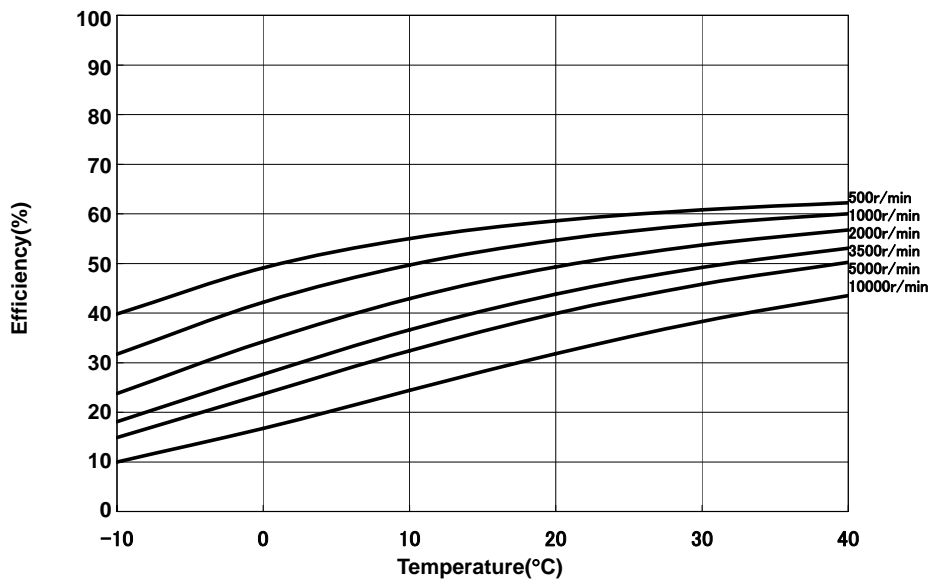

## Chapter 4 No-load running torque

No-load running torque means the torque required to put CSF-3 under a no-load condition.

\* Please contact your Harmonic Drive sales representative for more details.

### ● Measuring condition

Model : CSF-3-100-1U-CC (Gear Head Type)

Reduction ratio: 100

Measuring condition: Grease lubrication (Harmonic grease SK-2)

The torque value is the value after a trial run of at two hours at an input of 2000 r/min.

### ● Correction amount by reduction ratio

No-load running torques of Harmonic Drive vary in accordance with the reduction ratio. The values in Graph 1 below are the values for the gear head type (1U-CC, reduction ratio 1/100). Other reduction ratios can be calculated by adding correction amounts shown in Table 1.

Table 1

Unit: cNm

Reduction ratio	Double-axial unit type (1U)			Gear head type (1U-CC)	
	30	50	100	30	50
Correction amount	0.026	0.023	0.006	0.020	0.017

Graph 1 No-load running torque of gear head type (1U-CC, reduction ratio 1/100)

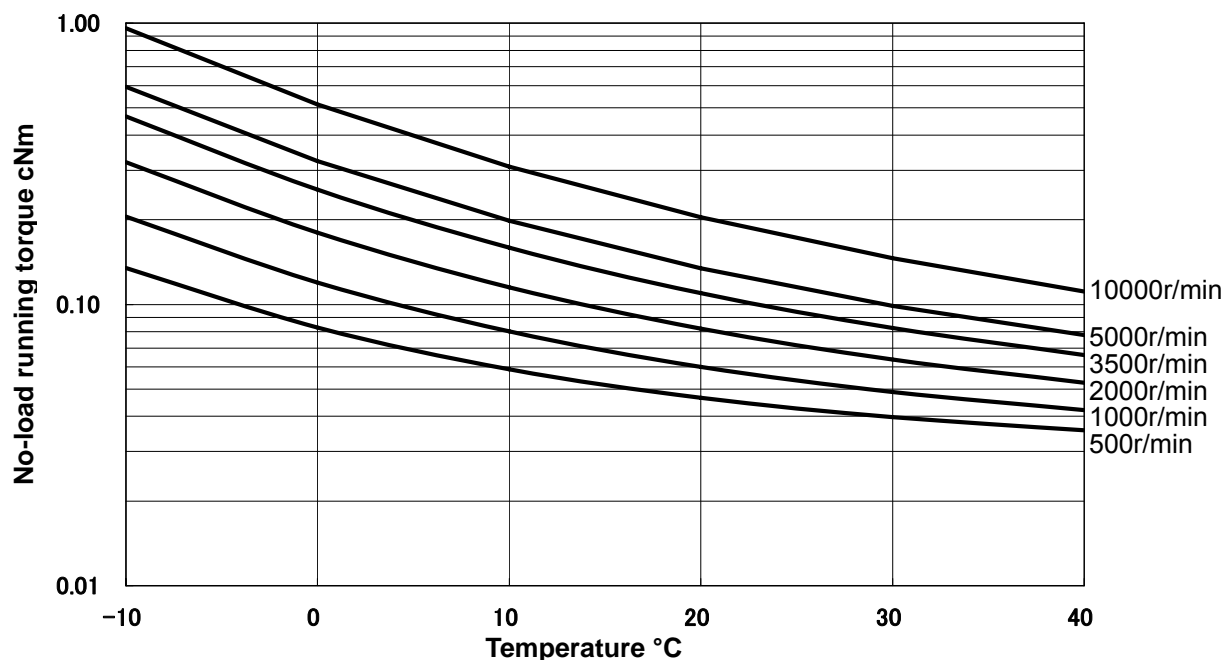

## Chapter 5 Starting torque and Overdrive starting torque

### ● Starting torque

Starting torque means the instantaneous “starting torque” that the output side (low-speed side) starts rotation when a torque is applied on the input side (high-speed side)

Double axial unit type(1U) Unit: cNm

Reduction Ratio	Starting torque
30	0.34
50	0.30
100	0.26

Gear head type(1U-CC) Unit: cNm

Reduction Ratio	Starting torque
30	0.32
50	0.28
100	0.24

### ● Overdrive starting torque

Overdrive starting torque means the instantaneous “starting torque” that the input side (high-speed side) starts rotation when a torque is applied on the output side (low-speed side)

Double axial unit type(1U) Unit: cNm

Reduction Ratio	Overdrive starting torque
30	0.14
50	0.14
100	0.16

Gear head type(1U-CC) Unit: cNm

Reduction Ratio	Overdrive starting torque
30	0.12
50	0.11
100	0.13

### ● Measuring condition

No-load, ambient temperature: +20°C

\* Use values on the following table as reference values as they vary depending on the usage conditions.

## Chapter 6 Ratcheting torque and Buckling torque

### ●Ratcheting torque

When excess impact torque is applied during operation, the engagement of the teeth between the circular saline and the flexspline may be put momentarily out of alignment instead of damaging the flexspline. This phenomenon is called ratcheting, and the torque is called ratcheting torque (see values on the corresponding page of each series). Operating the drive without fixing ratcheting will result in earlier abrasion of the teeth and shorter lifespan of the wave generator bearing due to the effect of the grinding powder generated by ratcheting.

Unit: Nm

Reduction ratio	Ratcheting torque
30	0.88
50	0.83
100	0.74

### ●Buckling torque

When excess torque is applied to the flexspline (output) with the wave generator fixed, the flexspline causes elastic deformation, buckles on the body before long and will be destroyed. The torque at the time is called buckling torque.

Unit: Nm

All reduction ratio	Buckling torque
	3.7



## Chapter 7 Angle transmission accuracy

Angle transmission accuracy indicates the difference between the logical rotating angle and the actual rotating angle as the angle transmission error when any rotating angle is given as an input.

Example of measurement

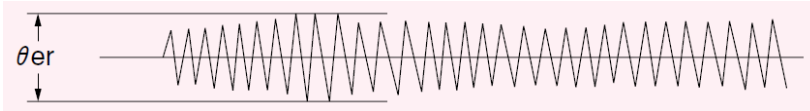

$$\theta_{er} = \theta_2 - \frac{\theta_1}{R}$$

$\theta_{er}$  .....Angle transmission error

$\theta_1$  .....Input rotating angle

$\theta_2$  .....Actual output rotating angle

R .....Reduction ratio of Harmonic Drive (i=1:R)

Angle transmission accuracy (Full speed ratio)

Unit	Angle transmission accuracy (Full speed ratio)
$\times 10^{-3}$ rad	2.9
arc min	10

## Chapter 8 Vibration

The angle transmission error elements of Harmonic Drive may appear as rotating vibration of the load side inertia.

Especially when the characteristic frequency of the vibration system including Harmonic Drive overlaps that of the chassis or load inertia, it generates a resonant condition that amplifies angle transmission error elements of Harmonic Drive. Observe Chapter 9 Design and Precautions on assembly.

Two angle transmission error elements of Harmonic Drive correspond to a cycle of the input shaft from the mechanical viewpoint of Harmonic Drive. Therefore, the frequency is double the input frequency as it is the main element of the error.

If the characteristic frequency of the vibration system including Harmonic Drive is  $F=15$  Hz, the input rotating speed (N) is expressed as shown below.

$$N = 15/2 \cdot 60 = 450 \text{ r/min}$$

The resonant condition is generated in the rotating speed area (450 r/min).

●How to obtain the characteristic frequency of the vibration system including Harmonic Drive

$$f = \frac{1}{2\pi} \cdot \sqrt{\frac{K}{J}}$$

Symbol of the calculation formula

f The characteristic frequency of the vibration system including Harmonic Drive : Hz

K Spring constant of Harmonic Drive: Nm/rad

J Load inertia:  $\text{kg} \cdot \text{m}^2$

# Chapter 9 Rigidity

Rigidity and backlash of the drive system greatly affects the performance of the servo system. A detailed review of these items is required before designing the equipment and selecting a model number.

## Rigidity

Fixing the input side (wave generator) and applying torque to the output side (flexspline) generates torsion almost proportional to the torque on the output side. Figure O18-1 shows the torsional angle quantity on the output side when the torque applied on the output side starts from zero, increases up to +T<sub>0</sub> and decreases down to -T<sub>0</sub>. This is called the "Torque – torsional angle diagram," which normally draws a loop of 0-A-B-A'-B'-A. The slope described in the "Torque – torsional angle diagram" is represented as the spring constant for the rigidity of Harmonic Drive (unit: Nm/rad). As shown in Figure O20-2, this "Torque – torsional angle diagram" is divided into 3 partitions, and the spring constants in the area are represented as K<sub>1</sub>, K<sub>2</sub> and K<sub>3</sub>.

K<sub>1</sub> – The spring constant when the torque changes from [zero] to [T<sub>1</sub>]

K<sub>2</sub> – The spring constant when the torque changes from [T<sub>1</sub>] to [T<sub>2</sub>]

K<sub>3</sub> – The spring constant when the torque changes from [T<sub>2</sub>] to [T<sub>3</sub>]

Torsional angle can be calculated by the following formulas.

\* φ: torsional angle

◆ Torque T is T<sub>1</sub> or less:  $\varphi = \frac{T}{K_1}$

◆ Torque T is between T<sub>1</sub> and T<sub>2</sub>:  $\varphi = \theta_1 + \frac{T - T_1}{K_2}$

◆ Torque T is between T<sub>2</sub> and T<sub>3</sub>:  $\varphi = \theta_2 + \frac{T - T_2}{K_3}$

The following table shows average values of T<sub>1</sub> to T<sub>3</sub>, K<sub>1</sub> to K<sub>3</sub> and θ<sub>1</sub> to θ<sub>2</sub>.

Spring constant

Model No.	Sign	Unit	Reduction ratio 30	Reduction ratio 50	Reduction ratio 100
3	T <sub>1</sub>	Nm	0.016	0.016	0.016
		kgf m	0.0016	0.0016	0.0016
	K <sub>1</sub>	Nm/rad	27	30	34
		×10 <sup>-4</sup> kgf m/arc min	8	9	10
	θ <sub>1</sub>	×10 <sup>-4</sup> rad	5.9	5.3	4.7
		arc min	2.0	1.8	1.6
	T <sub>2</sub>	Nm	0.05	0.05	0.05
		kgf m	0.005	0.005	0.005
	K <sub>2</sub>	Nm/rad	40	47	54
		×10 <sup>-4</sup> kgf m/arc min	12	14	16
	θ <sub>2</sub>	×10 <sup>-4</sup> rad	12.5	10.6	9.3
		arc min	4.2	3.6	3.1
	K <sub>3</sub>	Nm/rad	51	57	67
		×10 <sup>-4</sup> kgf m/arc min	15	17	20

Figure 1

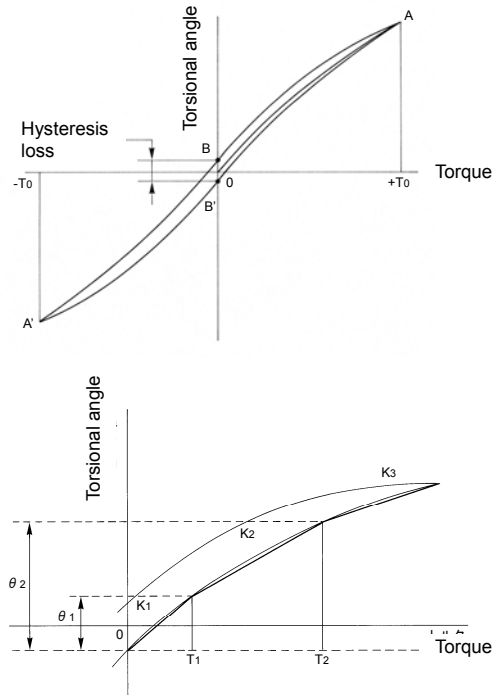

### Hysteresis loss

As shown in Figure 020-1, when the torque is applied up to the rated value and is brought back to [zero], the torsional angle does not become absolutely [zero] and a small amount remains. This is called hysteresis loss.

Hysteresis amount

Reduction ratio	Unit	Hysteresis amount
30	$\times 10^{-4}$ rad	1.3
	arc min	4.5
50	$\times 10^{-4}$ rad	1.2
	arc min	4
100	$\times 10^{-4}$ rad	1.2
	arc min	4

### Backlash

CSF-3 wave generators are of the rigid type (solid type) and are backlash free.

# Chapter 10 Design and Precautions on assembly

## 10-1 Embedding accuracy of gear head type (1U-CC)

Maintain the recommended case accuracy shown below in design for embedding to ensure that excellent performance of Harmonic Drive is fully demonstrated.

Recommended accuracy for case embedding

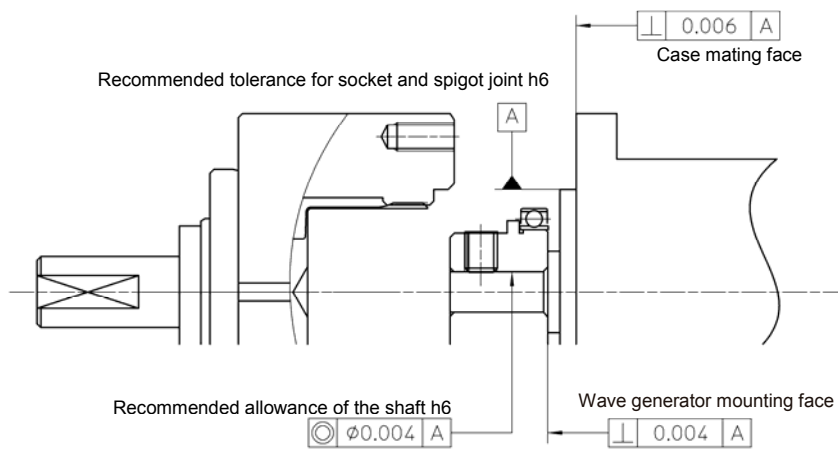

## 10-2 Tolerable load of input shaft of double-shaft unit type (1U)

The input part of the double-shaft unit type is supported by two single row deep groove bearings. Check the load applied to the input part to ensure that the performance of the double-shaft unit type is fully demonstrated.

The following diagram illustrates the fulcrums of the bearings. Dimensions “a” and “b” are shown in the following table. The following graph shows the relationship between the tolerable maximum radial load and axial load of Model No. 3. The values in the graph are those when the average input rpm is 2,000r/min and basic rated life of  $L_{10} = 7,000h$ .

Example: The maximum tolerable radial load ( $F_r$ ) will be 3.75N when an axial load ( $F_a$ ) of 3N is applied to the input shaft.

Specification of bearings in input part

Bearing A			Bearing B			Maximum radial load $F_r(N)$
Model No.	Basic dynamic rated load $C_r(N)$	Basic static rated load $C_{or}(N)$	Model No.	Basic dynamic rated load $C_r(N)$	Basic static rated load $C_{or}(N)$	
MF63T12ZZ	242	94	681X	102	29	6

Bearing fulcrums

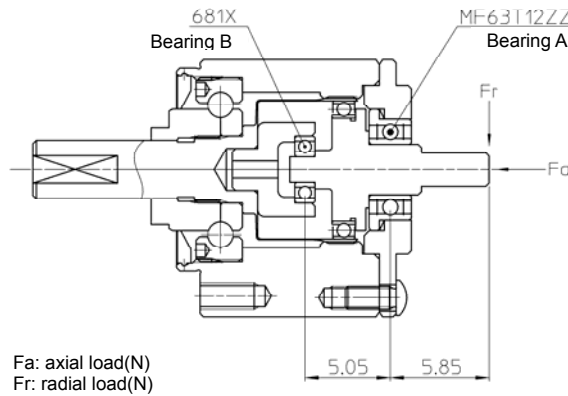

Relationship between axial load ( $F_a$ ) and tolerable maximum radial load ( $F_r$ )

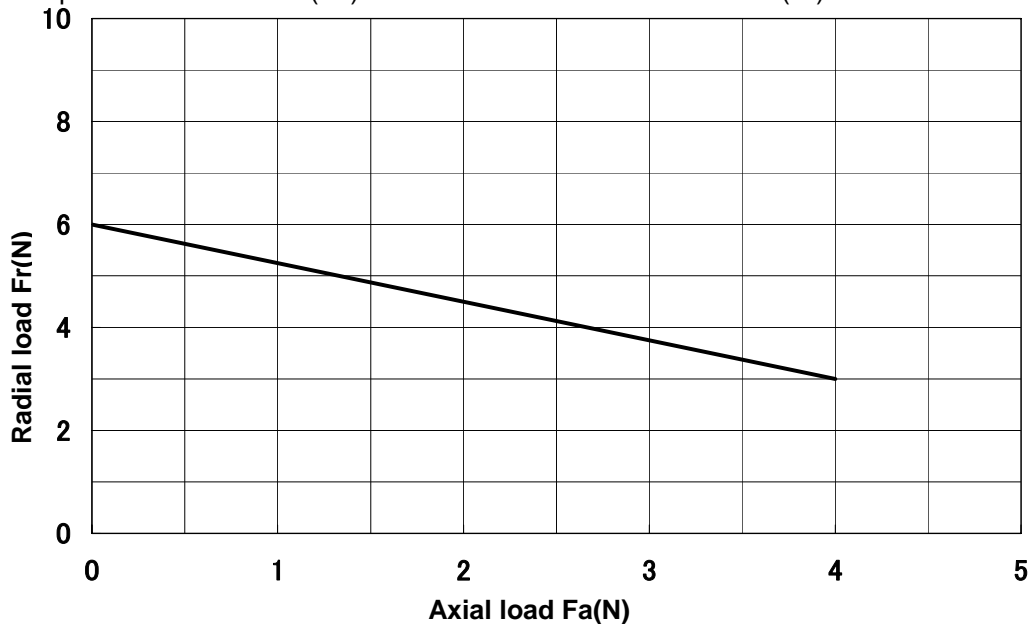

### 10-3 Mounting in system

When mounting the CSF-3 series in a system, check flatness of the mounting surface and burrs in the tap part. Then clamp the mounting flange (Part A in the diagram) by bolting.

#### Bolt tightening torque for mounting flange

Model No.	3	
Number of bolts	4	
Bolt size	M1.6	
Mounting PCD	mm	15
	Nm	0.26
Tightening torque	kgf m	0.03
	mm	1.9
Minimum length for fastener fit	Nm	3.0
	kgf m	0.3

Recommended bolts: Hexagon socket head cap screws (JIS B 1176); strength, 12.9 or better (JIS B 1051)

#### Mounting flange

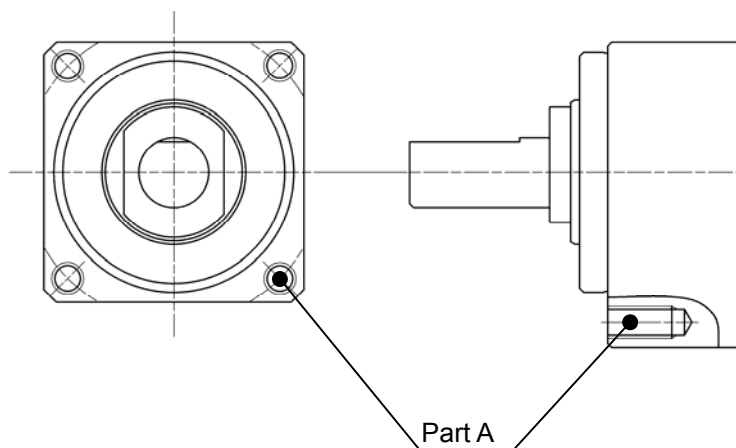

## 10-4 Mechanical accuracy

Using ultra compact and high accuracy 4-point contact ball bearings as the main bearings, the CSF-3 series features a high accuracy of its output part.

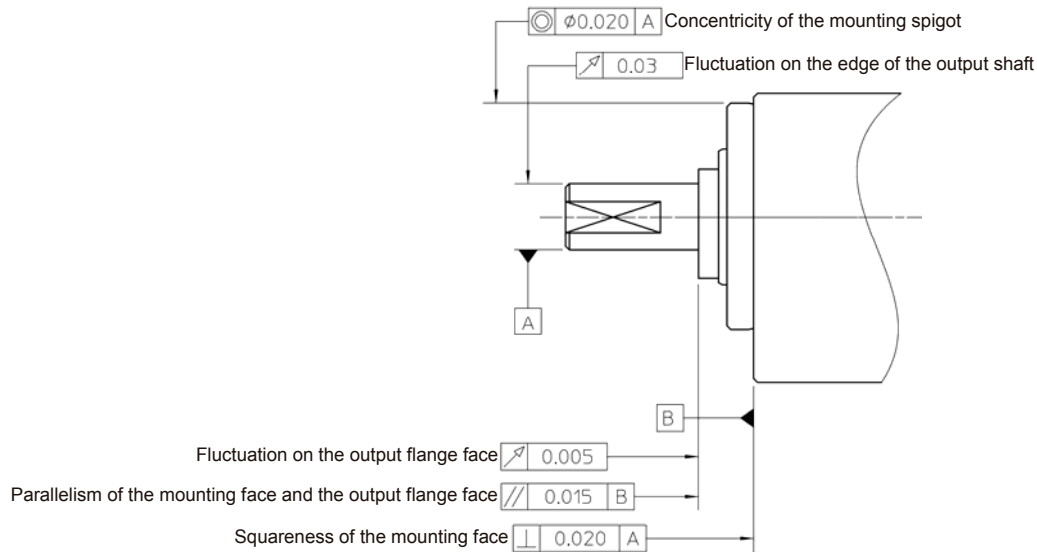

## 10-5 Lubricant

The standard lubricating method for the CSF-3 series is greasing of Harmonic Grease SK-2 developed specially for compact precision equipment. The CSF-3 series products are greased during preshipment inspection. No greasing or grease coating is needed when mounting them in systems.

### Grease specification

Lubricant name	Harmonic grease SK-2
Manufacturer	Harmonic Drive Systems
Ambient temperature range	0°C to +40°C
Base oil	Refined oil
Puffing agent	Lithium soap base
Additive	Extreme-pressure additive, others
NLGI consistency No.	No.2
Consistency (25°C)	265 to 295
Drop point	198°C
Appearance	Green
Storage life	5 years in sealed condition



# Memo

## Warranty Period and Terms

Products that are described in this catalog are warranted as follows:

### ■ Warranty period

Under the condition that the products are handled, used and maintained properly followed each item of the technical materials, the manuals, and this catalog, all the products are warranted against defects in workmanship and materials for the shorter period of either one year after delivery or 2,000 hours of operation time.

### ■ Warranty terms

All the products are warranted against defects in workmanship and materials for the warranted period. This limited warranty does not apply to any product that has been subject to:

- (1) User's misapplication, improper installation, inadequate maintenance, or misuse.
- (2) Disassembling, modification or repair by others than Harmonic Drive Systems, Inc.
- (3) Imperfection caused by the other than the products.
- (4) Disaster or others that does not belong to the responsibility of Harmonic Drive Systems, Inc.

Our liability shall be limited exclusively to repairing or replacing the product only found by Harmonic Drive Systems, Inc. to be defective. Harmonic Drive Systems, Inc. shall not be liable for consequential damages of other equipment caused by the defective products, and shall not be liable for the incidental and consequential expenses and the labor costs for detaching and installing to the driven equipment



Certified to ISO14001 (HOTAKA Plant) / ISO9001 (TÜV Management Service GmbH)  
All specifications and dimensions in this manual subject to change without notice.

	<p>Head Office: Believe Omori 7F 6-25-3 Minami-Ohi, Shinagawa-ku, Tokyo, Japan 140-0013 TEL +81-(0)3-5471-7800 FAX +81-(0)3-5471-7811</p> <p>Overseas Division: Believe Omori 7F, 6-25-3 Minami-Ohi, Shinagawa-ku, Tokyo, Japan 140-0013 TEL +81-(0)3-5471-7800 FAX: +81-(0)3-5471-7811</p> <p>Hotaka Plant: 1856-1 Maki, Hotaka, Azumino-shi, Nagano, Japan 399-8305 TEL +81-(0)263-83-6800 FAX +81-(0)263-83-6901</p> <p>Harmonic Drive AG: Hoenbergstrasse 14 D-65555 Limburg a.d. Lahn Germany TEL +49-6431-5008-0 FAX +49-6431-5008-18</p> <p>Harmonic Drive L.L.C.: 247 Lynnfield Street, Peabody, MA, 01960, U.S.A. TEL 978-532-1800 FAX 978-532-9406</p>
--	--